

Welcome!

Flinn Scientific

Year-Round Solutions for Success in AP* Chemistry

*AP is a registered trademark of the College Board, which was not involved in the production of, and does not endorse, this product.

1

Resources for the Entire Year

- **Dynamic Demos**
 - Colorful Electrolysis
 - Upset Tummy (Acid-Base Chemistry)
- **POGIL (Process Oriented Guided Inquiry Learning)**
 - Reaction Quotient
 - Polar and Nonpolar Molecules
- **Advanced Inquiry Labs from Flinn Scientific**
 - Hand-held Battery Activity
- **FlinnPrep**
- **Advanced Inquiry Labs from Flinn Scientific cont.**
 - Designing A Hand warmer
- **AP-style Free Response Questions and More!**
 - Photoelectron Spectroscopy

Dynamic Demos

- Can be use to teach multiple concepts!
 - Free tech support!
 - Easy to use kits!
-
- Colorful Electrolysis
 - Upset Tummy (Milk of Magnesia and Acid)

Colorful Electrolysis

- Redox Reactions
- Electrolysis
- pH

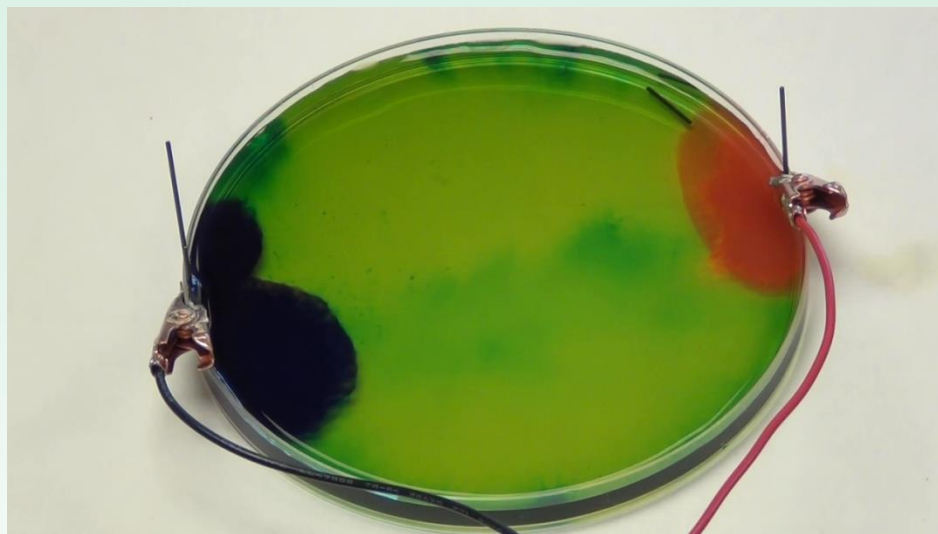

- Cathode: $4e^- + 4H_2O \rightarrow 2H_2(g) + 4OH^-$
- Anode: $2H_2O \rightarrow O_2(g) + 4H^+ + 4e^-$

More Electrolysis Activities!

- Hoffman Apparatus
- Electrolysis of Water Lab



5

Upset Tummy? MOM to the Rescue

- Acid – base neutralization
- Solubility
- Chemical indicators
- Equilibrium
- Consumer chemistry

Upset Tummy? MOM to the Rescue

Universal Indicator Color Chart

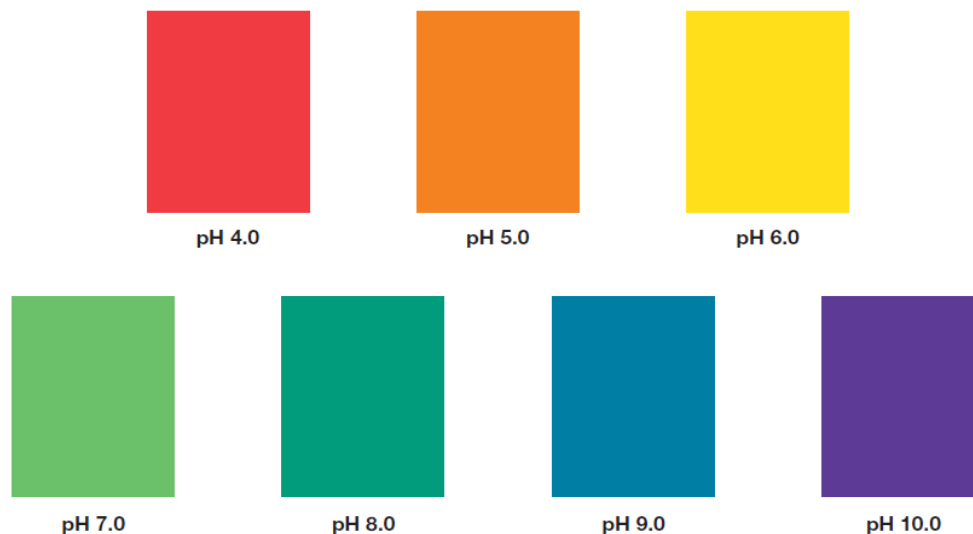

FLINN
SCIENTIFIC, INC. | "Your Safer Source for Science Supplies"

© 2011 Flinn Scientific, Inc. All Rights Reserved.

BAP7498A

AP POGIL Activities

- Process Oriented Guided Inquiry Learning (POGIL)
- Increase problem solving, content mastery, and analytical reasoning skills.
- Series of guiding questions used to interpret data and trends.

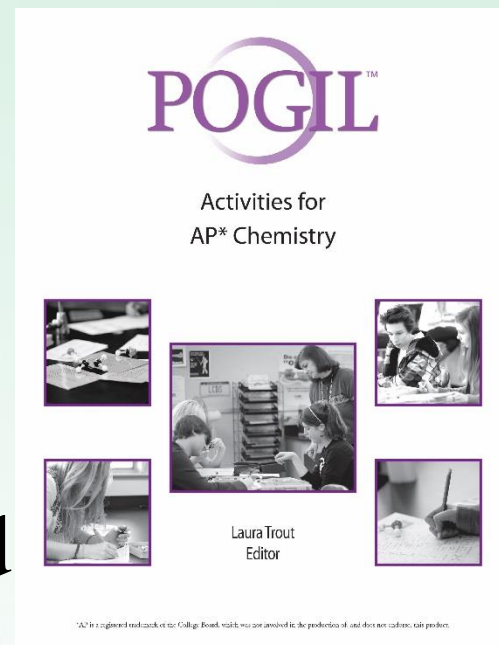

POGIL Roles Example

- Group students and assign roles! For example, in a group of three, you can assign a
 - Leader – In charge of the group and orchestrating who reads the POGIL out loud. The instructor will answer questions from the leader only.
 - Recorder – In charge of summarizing the main points of the activity and individual group discussions. Turns in a separate summary to the teacher at the end of the period (great way to check for student understanding).
 - Presenter – At designated stopping points, this student stands up and shares his or her group's answers and reasoning.

Advanced Chemistry POGIL Topics Included:

- Mass Spectroscopy
- Empirical Formulas
- Combustion Analysis
- Net Ionic Equations
- Advanced Periodic Trends
- Photoelectron Spectroscopy
- Types of Bonds
- **Polar and Nonpolar Molecules**
- Properties of Covalent Bonds
- Lattice Energy
- Types of Solids
- Alloys
- Partial Pressure of gases
- Deviations from the Ideal Gas Law
- Maxwell-Boltzmann Distributions
- Heats of Formation
- Rates of Reaction
- Method of Initial Rates
- Free Energy
- Work, Equilibrium and Free Energy
- **Reaction Quotient**
- Common Ion Effect on Solubility
- Fractional Precipitation
- Common Ion Effect on Acid Ionization
- Buffers
- Strengths of Acids
- Titration Curves Polyprotic Acids
- Electrochemical Cell Voltage
- Faraday's Law

POGIL Activities cont.

Reaction Quotient

How do you predict which direction a reaction will proceed to reach equilibrium?

Why?

When a reaction reaches equilibrium there must be some non-negligible amount of every species in the reaction, otherwise the reaction cannot react in both directions. Knowing this, it is very easy to predict which direction a reaction will go to reach equilibrium when one of the components of the reaction has an initial concentration of zero. Many of the problems you have worked with thus far have some component at zero concentration, but real life does not work that way. Most of the time, the reaction in question has some measurable amount of every species. Deciding which way the reaction will go to reach equilibrium then becomes more challenging.

Model 1 – A Theoretical Equilibrium

Trial 1	A(g) + B(g) \leftrightarrow C(g)		
Initial	1.000 M	1.000 M	1.000 M
Change	←		
Equilibrium	1.464 M	1.464 M	0.536 M

Trial 3	A(g) + B(g) \leftrightarrow C(g)		
Initial	1.000 M	0.500 M	1.500 M
Change			
Equilibrium	1.864 M	1.364 M	0.636 M

Trial 5	A(g) + B(g) \leftrightarrow C(g)		
Initial	1.400 M	1.200 M	0.400 M
Change			
Equilibrium	1.388 M	1.188 M	0.412 M

Trial 2	A(g) + B(g) \leftrightarrow C(g)		
Initial	2.000 M	0.500 M	0.500 M
Change			
Equilibrium	2.150 M	0.650 M	0.350 M

Trial 4	A(g) + B(g) \leftrightarrow C(g)		
Initial	1.600 M	1.000 M	0.400 M
Change			
Equilibrium	1.600 M	1.000 M	0.400 M

Trial 6	A(g) + B(g) \leftrightarrow C(g)		
Initial	0.750 M	2.000 M	0.250 M
Change			
Equilibrium	0.675 M	1.925 M	0.325 M

POGIL Activities cont.

Read This!

The key to knowing which direction a reaction will need to proceed in order to reach equilibrium is knowing if you have too much reactant or too much product compared to the equilibrium state. Keep in mind however that there are many combinations of reactant and product concentrations that constitute an equilibrium state.

Model 2 – Comparing Q and K_{eq}

Trial	Reaction Quotient, Q	Equilibrium Constant, K_{eq}	Q versus K_{eq}	Direction to Equilibrium
1	1.000	0.250	>	←
2	0.500	0.250	>	←
3	3.00	0.250	>	←
4	0.250	0.250	=	No change
5	0.238	0.250	<	→
6	0.167	0.250	<	→

10. Fill in the Equilibrium Constant column in Model 2 using data from Model 1.

See Model 2.

11. Fill in the Direction to Equilibrium column in Model 2 using data from Model 1.

See Model 2.

Read This!

The **reaction quotient** for a reaction is the ratio of products to reactants, similar to the equilibrium constant. The difference is you calculate the ratio with initial conditions.

$$K_{eq} = \frac{[C]_{eq}}{[A]_{eq}[B]_{eq}} \quad Q = \frac{[C]_{initial}}{[A]_{initial}[B]_{initial}}$$

12. Calculate the reaction quotient for each of the trials in Model 1 and record the data in Model 2 in the appropriate column. Divide the work among group members. Show your work below.

Trial 1

$$Q = \frac{(1.000 M)}{(1.000 M)(1.000 M)}$$

$$Q = 1.000$$

Trial 2

$$Q = \frac{(0.500 M)}{(2.000 M)(0.500 M)}$$

$$Q = 0.500$$

Trial 3

$$Q = \frac{(1.500 M)}{(1.000 M)(0.500 M)}$$

$$Q = 3.000$$



Polar and Nonpolar Molecules

What makes a molecule polar?

Why?

The physical properties of a substance are dictated in part by whether or not a molecule is polar. For example, oil and water do not mix because water is polar whereas oil is nonpolar. Another example is carbon dioxide and water. At room temperature, carbon dioxide is a gas while water is a liquid because carbon dioxide is nonpolar while water is polar. In this activity, you will explore the factors that contribute to a molecule's polarity or nonpolarity.

Model 1 – Examples of Nonpolar and Polar Molecules

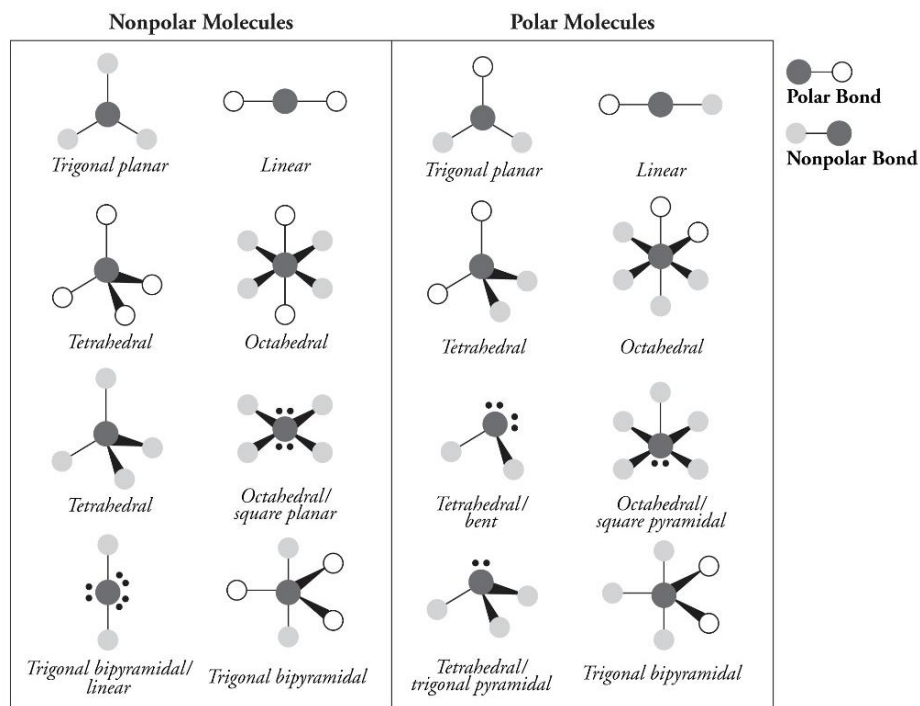

1. Consider Model 1. How is a polar bond differentiated from a nonpolar bond?

Polar bonds are indicated by an outer atom that is an open circle. Nonpolar bonds are indicated by an outer atom that is a shaded circle.

2. Formaldehyde has the chemical formula CH_2O , and it is trigonal planar. Draw this molecule using open and shaded circles as it might be shown in Model 1.

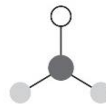

3. Label each diagram in Model 1 with the three-dimensional electronic shape that it represents.
See Model 1.

4. According to Model 1, can the shape of a molecule explain polarity? Justify your reasoning.
No, there are molecules of each type of shape represented in both the polar category and the nonpolar category. Therefore, shape alone cannot be the explanation for the polarity of a molecule.

5. Refer to Model 1. Circle the correct word to complete each sentence.

a. Nonpolar molecules (never, may, always) contain polar bonds.

b. Polar molecules (never, may, always) contain polar bonds.

6. A student states “Polar molecules are just molecules that contain polar bonds. If there are no polar bonds, then the molecule is nonpolar.” Do you agree or disagree with this statement? Justify your reasoning using evidence from Model 1.

No, Model 1 shows both polar and nonpolar molecules that contain polar bonds. It is not as simple as polar bonds = polar molecules.

7. How is a lone pair of electrons illustrated in Model 1?

A lone pair is shown as two black dots on the center atom.

8. Refer to Model 1. Circle the correct word to complete the sentence.

a. Nonpolar molecules (never, may, always) contain lone pairs of electrons.

b. Polar molecules (never, may, always) contain lone pairs of electrons.

9. Is the presence or absence of a lone pair of electrons sufficient to explain the polarity of molecules? Justify your reasoning using evidence from Model 1.

No, Model 1 shows both polar and nonpolar molecules that contain a lone pair on the center atom. It is not as simple as lone pair = polar molecule.



10. Refer to Model 1.

a. When polar bonds are present in a nonpolar molecule, how are they arranged around the center atom—on the same side of the molecule or on opposite sides of the molecule?

When polar bonds are present in a nonpolar molecule, the bonds are on opposite sides of the molecule.

b. When polar bonds are present in a polar molecule, how are they arranged around the center atom—on the same side of the molecule or on opposite sides of the molecule?

When polar bonds are present in a polar molecule, the bonds are on the same side of the molecule.

POGIL Activity

- Great student-centered learning activity.
- Students are asked to interpret and recognize trends.
- Models and data illustrate key concepts.

Advanced Inquiry Labs and Demos for Your Classroom!



- New! Wet/Dry Inquiry Labs for One Period!
- Advanced Inquiry Demos!
- Advanced Inquiry Lab Manual
 - Meets AP* Chemistry Curriculum Guidelines (Emphasizes Inquiry)
- We also sell Classic Advanced Chemistry Labs!

Hands On Activities!

- Hand-held Battery Lab Activity

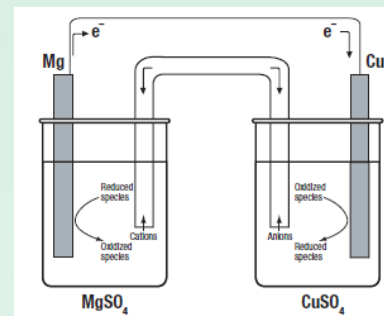

9. The materials to build your very own hand-held battery include: 2 small squares of filter paper, 1 M copper(II) sulfate solution, 1 M sodium sulfate solution, magnesium ribbon, and an LED with copper tape attached to the positive terminal. Again, the challenge is to build a hand-held battery by successfully arranging the components to light the LED. *Helpful tips:*
- Think safety, first. Make sure you have the proper PPE available to perform this lab, i.e., goggles, apron, and gloves.
 - Make a list of the equipment and glassware needed for this lab.
 - Once you successfully complete the experiment, draw a hand-held battery figure in your notebook and label the parts of your battery, i.e. the cathode, anode etc. Write the reactions occurring.
 - How does this battery differ from those practiced in the homework set? How is it similar?
 - What are the half-cell reactions?
 - Inspect the separate components of the hand-held battery after connecting it and lighting the LED. Describe any observations.

Hands On Activities!

- Hand-held Battery Lab Activity

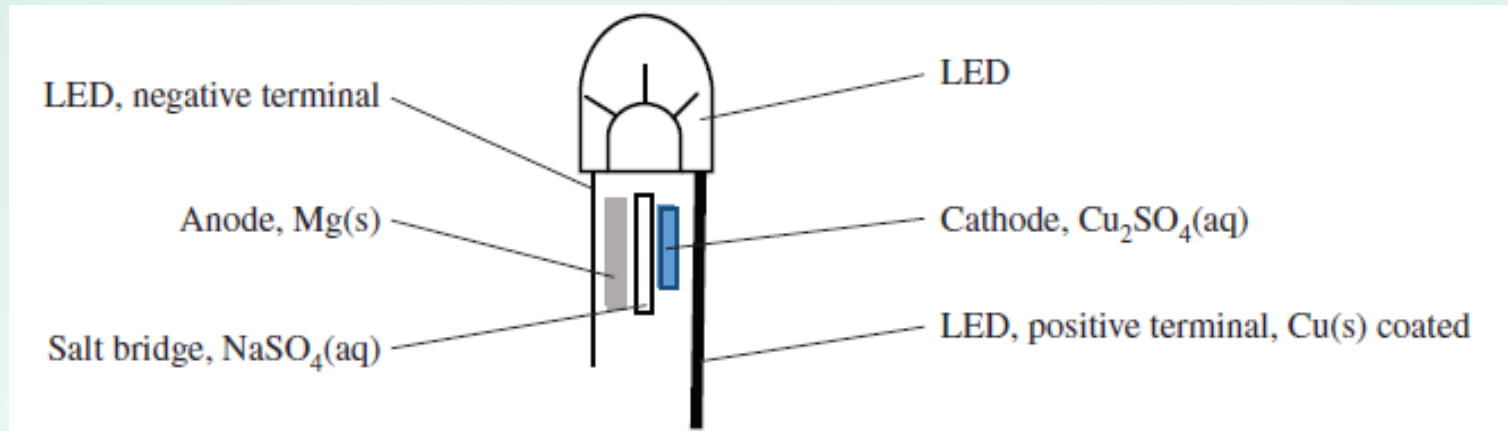

Discover **FLINN***PREP*TM



Have a Student Linking Code from Your Teacher?

Discover **FLINN***PREP*TM

Year-round learning to keep your students actively engaged in current material, review foundational concepts, and provide supplemental resources to challenge them for a more rigorous curriculum.

Why Choose **FLINN***PREP*TM ?

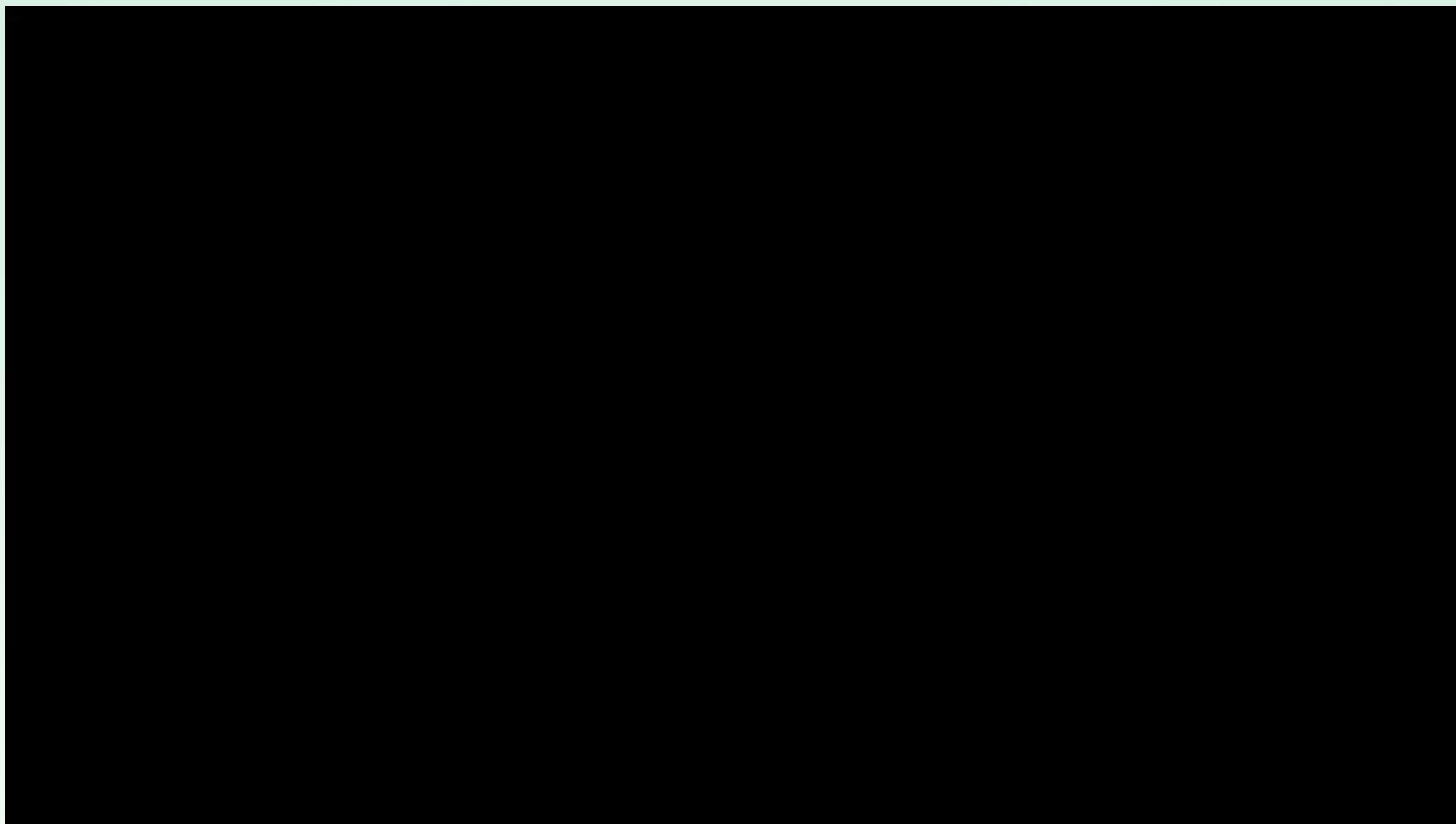



AP* Chemistry Prep Course

Foundational topics and common AP* Chemistry concepts covered include: nomenclature, the periodic table, bonding, chemical reactions, stoichiometry, solutions, structures and properties, gases, and acids and bases.

AP* level supplemental Chemistry content includes kinetics, equilibrium, thermochemistry, electrochemistry, and photoelectron spectroscopy.





Interactive Learning

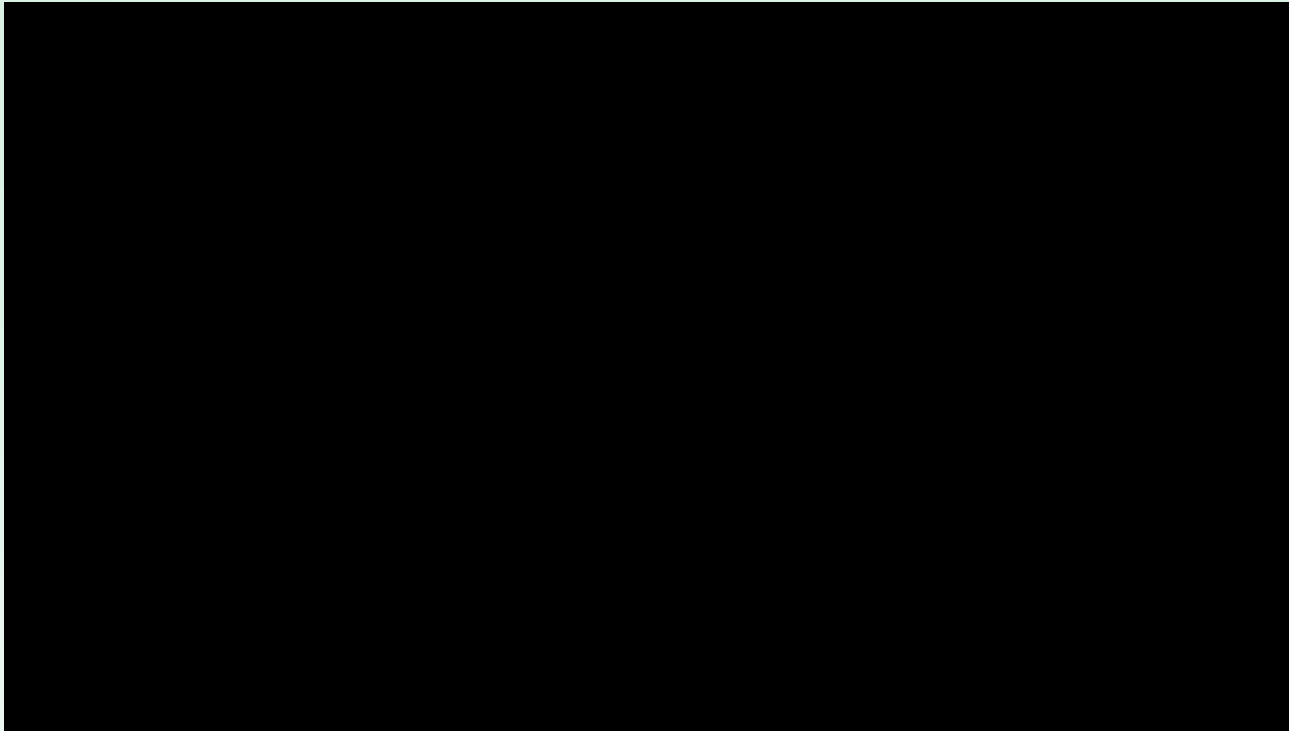

Student success is achieved through innovative techniques that foster learning! FlinnPREP™ courses use a variety of interactive learning strategies to keep students engaged and deliver content in unique ways to reinforce learning objectives.



Interactive Learning

What Have You Learned So Far?

Choose the type of bond formed between the two Cl atoms in a Cl_2 molecule.

- Single
- Double
- Triple
- Ionic

The correct answer is a single. The Cl_2 molecule has a total of 14 valence electrons available for its Lewis structure. The only way to distribute those 14 electrons to maintain each atoms' octet is by forming a single bond and placing 6 nonbonding electrons (dots) on each Cl atom. See Figure 11.

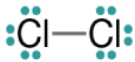
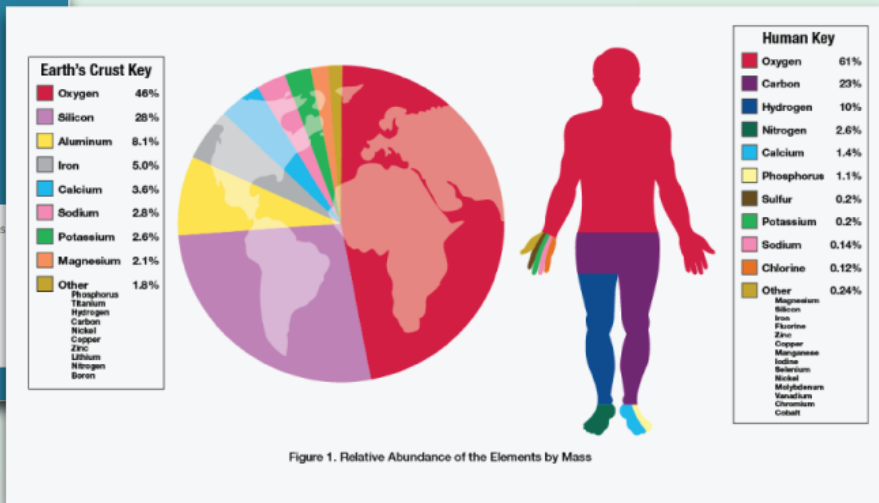

Figure 11. Cl_2 Lewis Structure



Quick Quizzes at variable check points challenge students' comprehension and critical thinking skills to ensure that students have a clear understanding of the material as they progress through the course. End-of-unit assessments provide significant data points of understanding for both students and teachers.

Easy-to-follow text, video, animation, and detailed graphs throughout each unit teach concepts while also providing reteach opportunities for students needing additional support. Students benefit from a variety of teaching methods which offer a personalized learning experience.



Interactive Learning

Reteach Videos

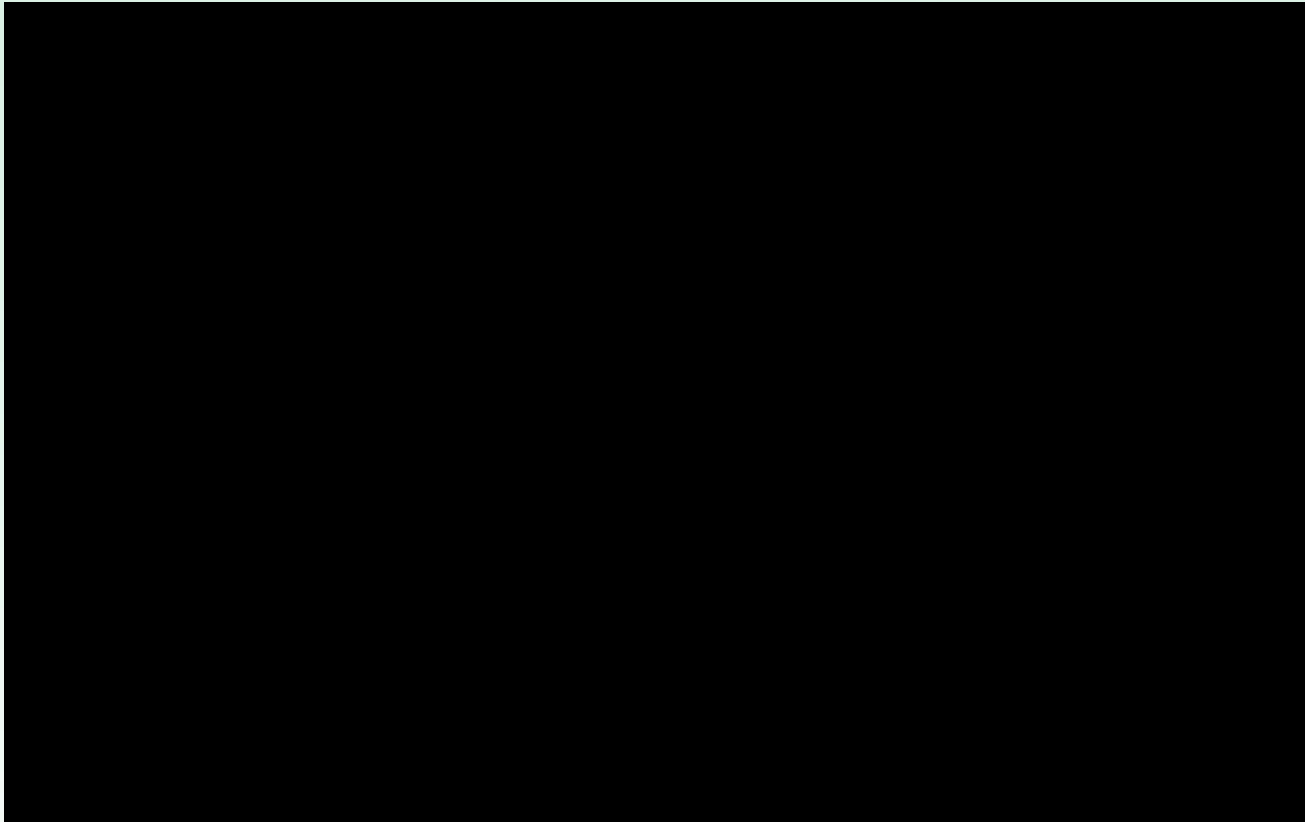



Anytime Anywhere Access

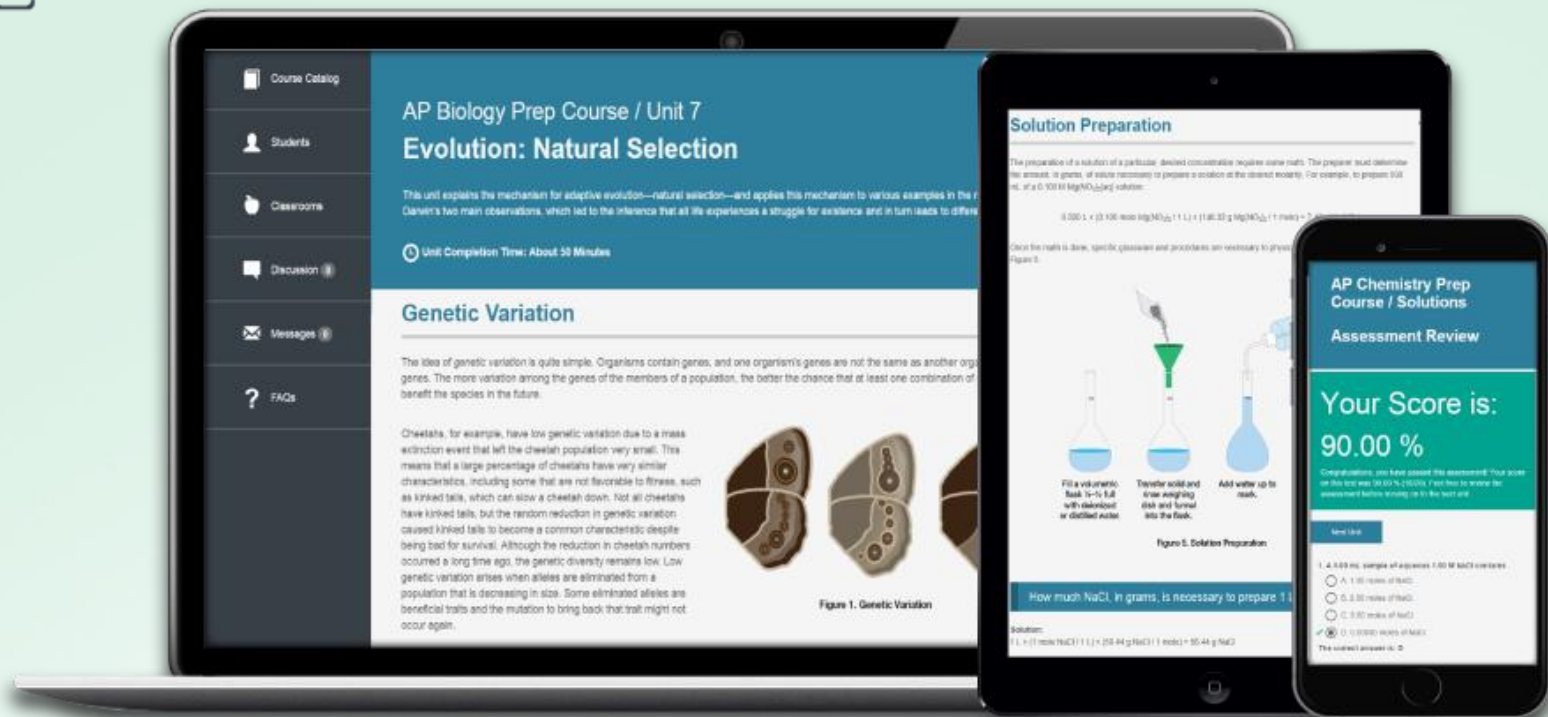

FlinnPREP™ can be accessed 24/7 from any computer or mobile device with an internet connection.

Progress monitoring tools and reports keep everyone informed on progress and concept mastery.



Progress Monitoring

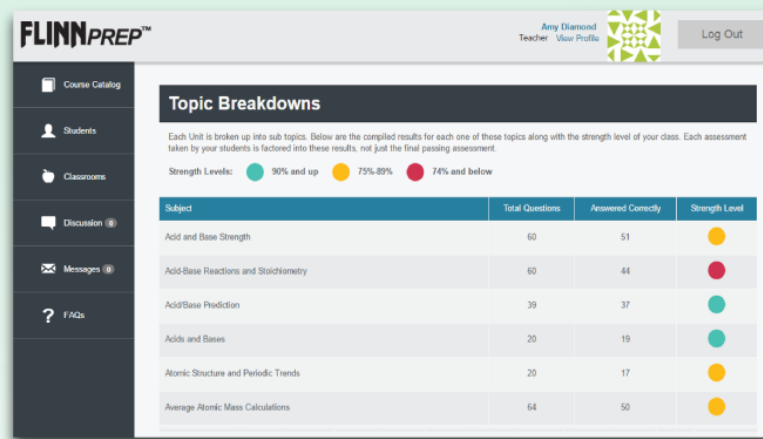
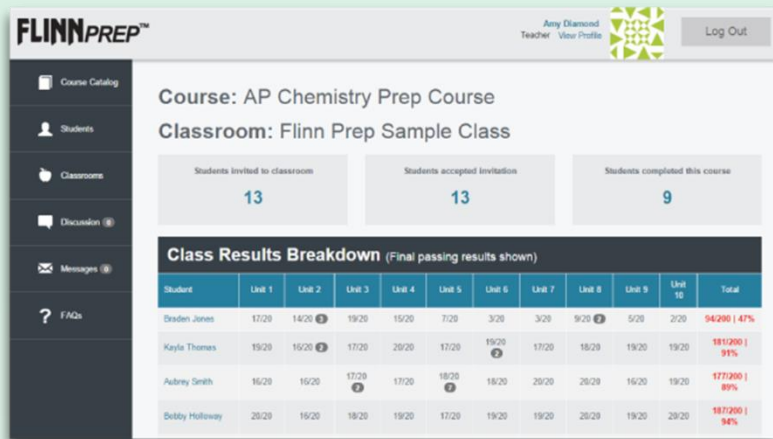

Teachers create a FlinnPREP™ teacher account for free and preview all course content at no charge. Teachers can also create a FlinnPREP™ classroom, invite students to join that classroom, and track progress throughout the course.

With FlinnPREP™, teachers will see the strengths and weaknesses of their students from a detailed perspective. The diagnostic reports provide a detailed analysis of the course performance at the unit level for individual students and for each teacher classroom. FlinnPREP™ also provides teachers with a detailed view of all student assessment results to determine where each individual student is struggling.

FlinnPREP™ courses contain multiple units of content and each unit is broken down into subtopics. Teachers have access to classroom and student reports that provide up-to-the minute results for each subtopic based on student assessment results. Strength level indicators provide teachers a clear picture of overall classroom performance.



Year-Round Learning



Replace the traditional summer review packet with an engaging review of foundational chemistry topics. FlinnPREP™ courses are broken down into multiple units and provide assessments to test student knowledge and gauge their strength.

FlinnPREP™ provides supplemental AP* level content optimized for a blended-learning approach. With FlinnPREP™, students benefit from year-round access to in-depth content that facilitates personalized learning. The results of each unit assessment will help teachers provide informed instruction and give students feedback to stay on target with AP* coursework.

Sample Practice Exams

The updated AP* Chemistry exam assesses conceptual and higher order cognitive skills. These redesigned exams have left large collections of sample exam questions outdated and less effective as preparatory tools.

Practice Exams Available Spring 2017

Available Spring, 2017 – Flinn Scientific has written a set of complete practice exams aligned with the style of the newly redesigned AP* exams. Each student with an active FlinnPREP™ course will have digital access to these full-length practice exams, at no extra charge.

Upcoming Enhancements

- Gamification!
- Enhanced Assessments
- Drag and Drop
- Glossary
- Open Education Resources (OER)

Upcoming Enhancements

Simple Drag and Drop / Matched Pairs

Match the number of moles of each compound to its equivalent mass in grams.

Moles of Compound	Mass in grams
3 moles $C_{12}H_{22}O_{11}$	870.60 g
4 moles $Pb(NO_3)_2$	1027.02 g
4 moles $Fe_2(SO_4)_3$	1324.88 g
5 moles $C_6H_6O_6$	1599.64 g

Upcoming Enhancements

Simple Drag and Drop / Matched Pairs

Moles of Compound		Mass in grams	
3 moles $C_{12}H_{22}O_{11}$	✓	1027.02 g	870.60 g
4 moles $Pb(NO_3)_2$	✗	870.60 g	1027.02 g
4 moles $Fe_2(SO_4)_3$	✓	1599.64 g	1324.88 g
5 moles $C_6H_6O_6$	✗	1324.88 g	1599.64 g

✗ Incorrect.
To convert moles into grams, determine the molar mass of the compound and multiply by the number of moles.
Click the Try Again button.

Try Again

Advanced Inquiry Labs and Demos for Your Classroom!



- New! Wet/Dry Inquiry Labs for One Period!
- Advanced Inquiry Demos!
- Advanced Inquiry Lab Manual
 - Meets AP* Chemistry Curriculum Guidelines (Emphasizes Inquiry)
- We also sell Classic Advanced Chemistry Labs!

Format for Advanced Inquiry Labs

- Background
- Experiment Overview
- Pre-Lab Questions – safety, principles, and calculations
- Introductory Activity – introduce lab technique, “rough” experiment to select range, etc.
- Guided Inquiry Design and Procedure – inquiry guidance provided by leading questions
- Teacher’s Notes

Designing a Hand Warmer – Intro Activity

- Design an effective hand warmer that is inexpensive, non-toxic, and environmentally safe.
- Determine heat capacity of calorimeter.
- Determine heat energy change for a solution of MgSO_4 .

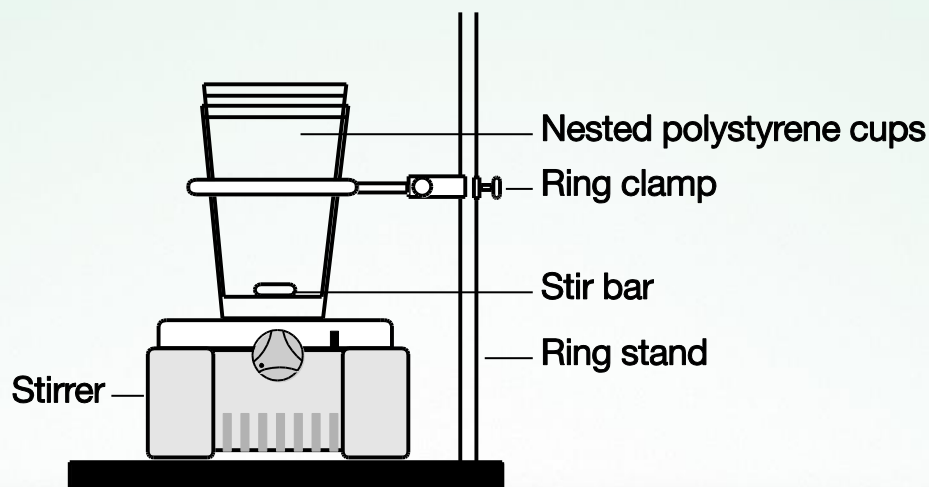

Design a Hand Warmer – Guided Inquiry Activity

Solid	Cost (\$/kg)	ΔT (experimental) 5 g/45 mL	ΔT (extrapolated) 10 g/40 mL
Sodium Chloride	0.0079	-1.4°C	N/A
Calcium Chloride	0.0131	14.4°C	31.9°C
Sodium Acetate	0.0258	4.7°C	10.3°C
Lithium Chloride	0.0655	19.2°C	43.2°C
Ammonium Nitrate	0.0181	-8.0°C	N/A

Advanced Inquiry Lab Manual

- All 16 Flinn advanced inquiry experiments for AP* Chemistry! Each lab has been tested, documented and optimized for safety, effective inquiry, and guaranteed success!
- Meets AP* Chemistry Curriculum Guidelines (Emphasizes Inquiry)
- Flinn Catalog No. AP7655
- We also sell Classic Advanced Chemistry Labs!

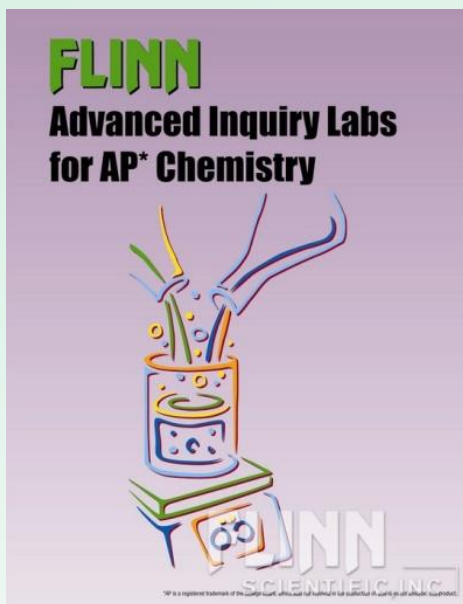

Advanced Inquiry Lab Investigations

- Analysis of Food Dyes in Beverages
- Percent Copper in Brass
- Gravimetric Analysis of Calcium and Hard Water
- Acidity of Beverages
- Separation of a Dye Mixture Using Chromatography
- Qualitative Analysis and Chemical Bonding
- Green Chemistry Analysis of a Mixture
- Analysis of Hydrogen Peroxide
- Separating a Synthetic Pain Relief Mixture
- Rate of Decomposition of Calcium Carbonate
- Kinetics of Crystal Violet Fading
- Designing a Hand warmer
- Applications of LeChatelier's Principle
- Acid-Base Titrations
- Buffers in Household Products
- Properties of Buffer Solutions

AP Style Free Response Questions



- Ten Free Response Practice Questions to help prepare your students for the AP Chemistry Exam.
- Two full length AP* Chemistry Practice Exams will be added to FlinnPrep Spring 2017!

AP Chemistry Flash Cards





FLINN
SCIENTIFIC, INC.
"Your Safer Source for Science Supplies"

P.O. Box 219 • Batavia, IL 60510
(800) 452-1261 • Fax (866) 452-1436
www.flinnsci.com • E-mail: flinn@flinnsci.com

Catalog No. AP7711

Publication No. 7711

Explain and Predict — Practice Free Response Questions for AP* Chemistry

Question 8

A sample of N_2O_5 gas is introduced into a cylinder with a piston. N_2O_5 decomposes and reaches equilibrium with its decomposition products according to the equation below: **(10 points)**

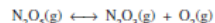

- Assume that N_2O_5 is brown and N_2O_3 is clear/colorless. How, via macroscopic observation, is it possible to determine the time necessary for the system to reach equilibrium? Justify your answer **(2 points)**.
- Write the K_p expression for the equilibrium **(1 point)**.
- The K_p for the equilibrium is 2.3×10^{-5} . Determine the partial pressures of all gaseous species present if the initial N_2O_5 pressure is 0.12 atm **(2 points)**.
- The piston is withdrawn slowly and then held in place. Will the value of K_p increase, decrease, or stay the same before returning to its original value? Justify your answer **(2 points)**.
- In another experiment, the flask is charged with N_2O_5 , N_2O_3 , and O_2 at the following partial, non-equilibrium pressures: 1.1 atm, 0.8 atm, and 2.4 atm, respectively. Predict whether the amount of gaseous oxygen in the container will increase, decrease, or stay the same. Justify your prediction **(2 points)**.
- Explain, with reference to microscale events, why the pressure of the system increases when the equilibrium shifts to the right **(1 point)**.

*AP is a registered trademark of the College Board, which was not involved in the production of, and does not endorse, these products.

CHEM-FAX!... makes science teaching easier.
© 2015 Flinn Scientific, Inc. All Rights Reserved.

IN7711
061515

Flinn Spectroscopy Activities



Photoelectron Spectroscopy

Evidence for Electronic Structure

Guided-Inquiry Learning Activity for AP[®] Chemistry

Introduction

The chemical properties of elements are based on the number of electrons in the neutral atom and the arrangement of electrons into shells and subshells reflecting specific or quantized energy levels. Photoelectron spectroscopy and ionization energy measurements provide direct evidence for the electronic structure of atoms.

Concepts

- Photoelectric effect
- Coulomb's law
- Electronic structure
- Planck's law
- Ionization energy
- Atomic orbitals
- Quantum theory
- Photoelectron spectroscopy

Background

Photoelectron spectroscopy (PES) utilizes the principles of the photoelectric effect to generate spectra revealing the electronic structure (energy levels) of atoms. A photoelectron spectrophotometer consists of three basic parts: a vacuum chamber for the sample, a radiation or light source, and an electron analyzer to separate electrons based on their kinetic energies (Figure 1).

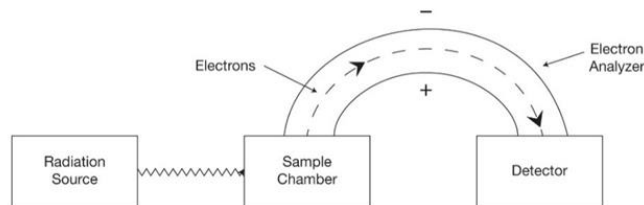

Figure 1. Basic features of a photoelectron spectrophotometer.

5. What determines the position of the peak in the spectrum? What is the numerical value of the peak for atom (element) A?
6. How many energy levels are represented by the photoelectron spectrum in Figure 4? Explain your reasoning.
7. Is it possible to determine how many electrons are present in A based on this spectrum? Explain.
8. The simulated photoelectron spectrum for a second hypothetical element is shown below. What does the number of peaks indicate about the energy levels for the electrons in this element?

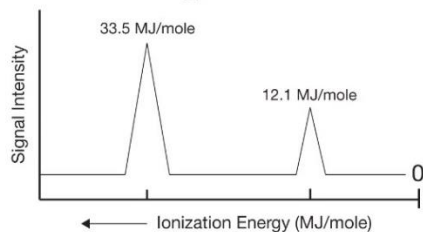
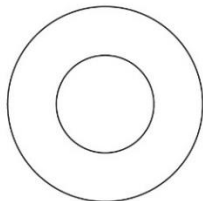

Figure 5. Simulated photoelectron spectrum.

9. What are the ionization energies for the electrons in Figure 5?
10. Which ionization energy value corresponds to an electron that is closer to the nucleus?
11. Compare the peak heights for the signals in this spectrum. Predict the relative number of electrons per atom originating from each energy level.
12. Complete the following shell diagram for this hypothetical element based on the photoelectron spectrum in Figure 5.



Flinn

- If you have any questions, give us a call or email! We'd love to help!

flinn@flinnsci.com

1-800-452-1261

